

AUDIO/VIDEO STEREO RECEIVER

KR-V8030

INSTRUCTION MANUAL

KENWOOD CORPORATION

KENWOOD

Introduction

Your choice of this product indicates that you are a devotee to excellence in sound reproduction.

We appreciate your patronage and take pride in the long tradition of quality components that our company represents.

So that you can get the most out of your unit, we suggest that you take the time to read through this manual before you hook up and operate your system. This will acquaint you with operating features and system-connection considerations so that your listening pleasure will be enhanced right from the start. You will notice that in all aspects of planning, engineering, styling, operating convenience and adaptability we have sought to anticipate your needs and desires.

Keep this manual handy for future reference.

For your records

Record the serial number, found on the back of the unit, in the spaces designated on the warranty card, and in the space provided below. Refer to the model and serial numbers whenever you call upon your dealer for information or service on this product.

Model _____ Serial Number _____

Unpacking

Unpack the unit carefully and make sure that all accessories are put aside so they will not be lost.

Examine the unit for any possibility of shipping damage. If your unit is damaged or fails to operate, notify your dealer immediately. If your unit was shipped to you directly, notify the shipping company without delay. Only the consignee (the person or company receiving the unit) can file a claim against the carrier for shipping damage.

We recommend that you retain the original carton and packing materials for use should you transport or ship the unit in the future.

Before operating the unit, remove packing material as shown below.

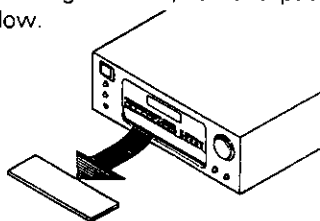

For the USA

Note to CATV system installer:

This reminder is provided to call the CATV system installer's attention to Article 820-44 of the NEC that provides guidelines for proper grounding and, in particular, specifies that the cable ground shall be connected to the grounding system of the building, as close to the point of cable entry as practical.

Accessories

FM indoor antenna 1 AM loop antenna 1

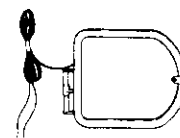
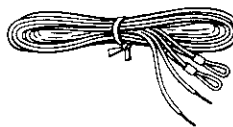

Loop antenna holder 1 Batteries (R6 or AA) 2

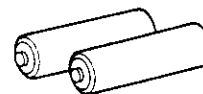

Remote control unit 1 AC plug adaptor 1 (except for some areas)

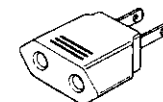
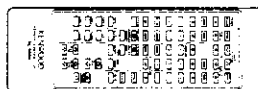

For the unit with a European AC plug in areas other than Europe.

Contents

Introduction	2
⚠ Before applying power	3
⚠ Safety precautions	3
⚠ IMPORTANT SAFEGUARDS	4
System connections	6
FM DE-EMPHASIS/CHANNEL SPACE switch	7
Control and indicators	10
Operation of remote control unit	12

Caution: Read the pages marked ⚠ carefully to ensure safe operation.

Basic operation	14
Listening to broadcasts	18
Operation with video components	22
DOLBY 3 STEREO	23
DOLBY SURROUND	24
In case of difficulty	28
⚠ Specifications	30

Before applying power

⚠ Caution: Read this page carefully to ensure safe operation.

For the U.S.A. and Canada

Important!

Units shipped to the U.S.A. and Canada are designed for operation on 120 volts AC only.

CAUTION: TO PREVENT ELECTRIC SHOCK DO NOT USE THE AC PLUG WITH AN EXTENSION CORD, RECEPTACLE OR OTHER OUTLET UNLESS THE BLADES CAN BE FULLY INSERTED TO PREVENT BLADE EXPOSURE.

For the United Kingdom

Important!

Units shipped to the U.K. are designed for operation on 240 volts AC only.

The mains plug must be removed from the wall socket prior to any internal examination.

The wires in this mains lead are coloured in accordance with the following code:

Blue Neutral
Brown Live

The wires in this mains lead must be connected to the terminals in the plug as follows:

Wire colour	Plug terminal marking
Blue	N or Black
Brown	L or Red

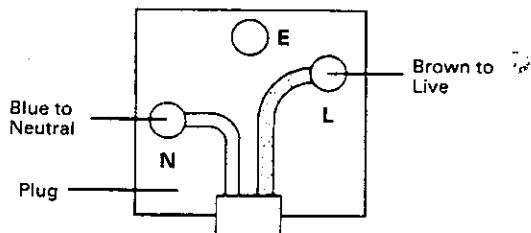

Notes:

1. If a 13-amp plug is used, this must be fitted with a 5-amp fuse.
2. If a 3-pin plug with earthing contact is used, no wire must be connected to the E terminal.

For Australia and Europe

Important!

Units shipped to Australia are designed for operation on 240 V AC only.

Units shipped to Europe are designed for operation on 230 V AC only.

For other countries

Important!

Units shipped to countries other than the above countries are equipped with an AC voltage selector switch on the rear panel. Refer to the following paragraph for the proper setting of this switch.

AC voltage selection

This unit operates on 110-120 or 220-240 volts AC. The AC voltage selector switch Type A or Type B on the rear panel is set to the voltage that prevails in the area to which the unit is shipped. Before connecting the power cord to your AC outlet, make sure that the setting position of this switch matches your line voltage. If not, it must be set to your voltage in accordance with the following direction.

Note:

Our warranty does not cover damage caused by excessive line voltage due to improper setting of the AC voltage selector switch.

AC voltage selector switch

Type A

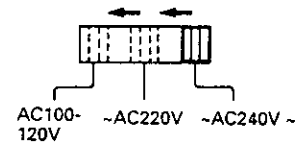

Type B

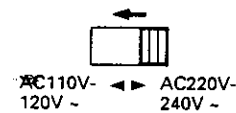

Move switch lever to match your line voltage with a small screwdriver or other pointed tool.

Safety precautions

WARNING: TO PREVENT FIRE OR SHOCK HAZARD, DO NOT EXPOSE THIS APPLIANCE TO RAIN OR MOISTURE.

	<p>CAUTION RISK OF ELECTRIC SHOCK DO NOT OPEN</p>		<p>CAUTION: TO REDUCE THE RISK OF ELECTRIC SHOCK, DO NOT REMOVE COVER (OR BACK). NO USER-SERVICEABLE PARTS INSIDE, REFER SERVICING TO QUALIFIED SERVICE PERSONNEL.</p>
	<p>THE LIGHTNING FLASH WITH ARROWHEAD SYMBOL, WITHIN AN EQUILATERAL TRIANGLE, IS INTENDED TO ALERT THE USER TO THE PRESENCE OF UNINSULATED 'DANGEROUS VOLTAGE' WITHIN THE PRODUCT'S ENCLOSURE THAT MAY BE OF SUFFICIENT MAGNITUDE TO CONSTITUTE A RISK OF ELECTRIC SHOCK TO PERSONS.</p>		
	<p>THE EXCLAMATION POINT WITHIN AN EQUILATERAL TRIANGLE IS INTENDED TO ALERT THE USER TO THE PRESENCE OF IMPORTANT OPERATING AND MAINTENANCE (SERVICING) INSTRUCTIONS IN THE LITERATURE ACCOMPANYING THE APPLIANCE.</p>		



Please read all of the safety and operating instructions before operating this unit. For best results, follow all warnings placed on the unit and adhere to the operating and use instructions. These safety and operating instructions should be retained for future reference.

1. Power sources – The unit should be connected to a power supply only of the type described in the operating instructions or as marked on the appliance.

2. Power-cord protection – Power-supply cords should be routed so that they are not likely to be walked on or pinched by items placed upon or against them, pay particular attention to cords at plugs, convenience receptacles, and the point where they exit from the unit.

Never pull or stretch the cord.



3. Grounding or polarization – The precautions should be taken so that the grounding or polarization means of this unit is not defeated.

4. Ventilation – The unit should be situated so that its location or position does not interfere with its proper ventilation.

To maintain good ventilation, do not put records or a table-cloth on the unit. Place the unit at least 10 cm away from the walls.

Do not use the unit on a bed, sofa, rug or similar surface that may block the ventilation openings.

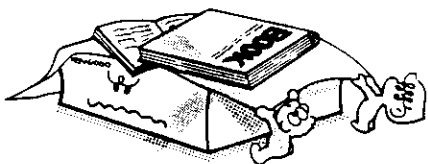

5. Water and moisture – The unit should not be used near water – for example, near a bathtub, washbowl, kitchen sink, laundry tub, in a wet basement, or near a swimming pool, etc.

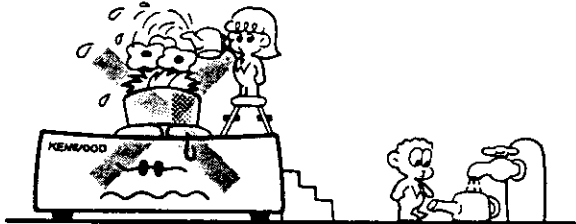

6. Temperature – The unit may not function properly if used at extremely low, or freezing temperatures. The ideal ambient temperature is above +5°C (41°F).

7. Heat – The unit should be situated away from heat sources such as radiators, heat registers, stoves, or other units (including amplifiers) that produce heat.

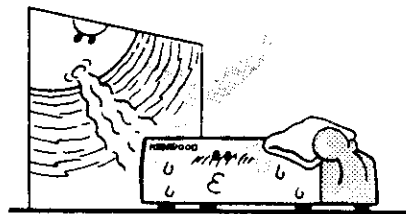

8. Electric shock – Care should be taken so that objects do not fall and liquid is not spilled into the enclosure through openings. If a metal object, such as a hair pin or a needle, comes into contact with the inside of this unit, a dangerous electric shock may result. For families with children, never permit children to put anything, especially metal, inside this unit.

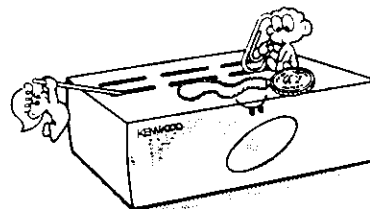

9. Enclosure removal – Never remove the enclosure. If the internal parts are touched accidentally, a serious electric shock might occur.

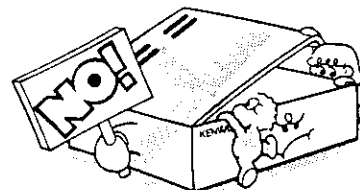

10. Magnetic fields – Keep the unit away from sources of magnetic fields such as TV sets, speaker systems, radios, motorized toys or magnetized objects.

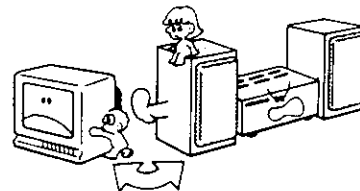

11. Cleaning – Do not use volatile solvents such as alcohol, paint thinner, gasoline, or benzine, etc. to clean the cabinet. Use a clean dry cloth.

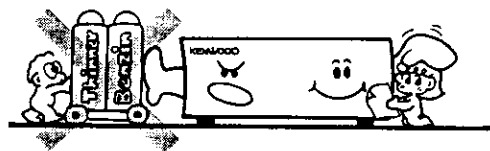

12. Carts and stands – An appliance and cart combination should be moved with care. Quick stops, excessive force, and uneven surfaces may cause the appliance and cart combination to overturn.



13. Nonuse periods – The power cord of the unit should be unplugged from the outlet when left unused for a long period of time.

14. Abnormal smell – If an abnormal smell or smoke is detected, immediately turn the power OFF and pull out the power cord. Contact your dealer or nearest service center.

POWER OFF!

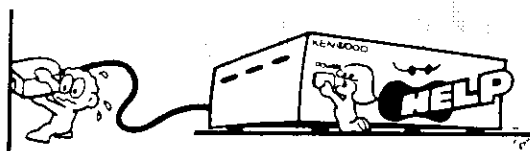

15. Damage requiring service – The unit should be serviced by qualified service personnel when:

- A. The power-supply cord or the plug has been damaged; or
- B. Objects have fallen, or liquid has been spilled into the unit; or
- C. The unit has been exposed to rain; or
- D. The unit does not appear to operate normally or exhibits a marked change in performance; or
- E. The unit has been dropped, or the enclosure damaged.

16. Servicing – The user should not attempt to service the unit beyond that described in the operating instructions. All other servicing should be referred to qualified service personnel.

17. Outdoor antenna grounding – If an outside antenna is connected to the receiver, be sure the antenna system is grounded so as to provide some protection against voltage surges and built up static charges. Section 810 of the National Electrical Code, ANSI/NFPA No. 70 – 1984, provides information with respect to proper grounding of the mast and supporting structure, grounding of the lead-in wire to an antenna discharge unit, size of grounding conductors, location of antenna-discharge unit, connection to grounding electrodes, and requirements for the grounding electrode. See Figure.

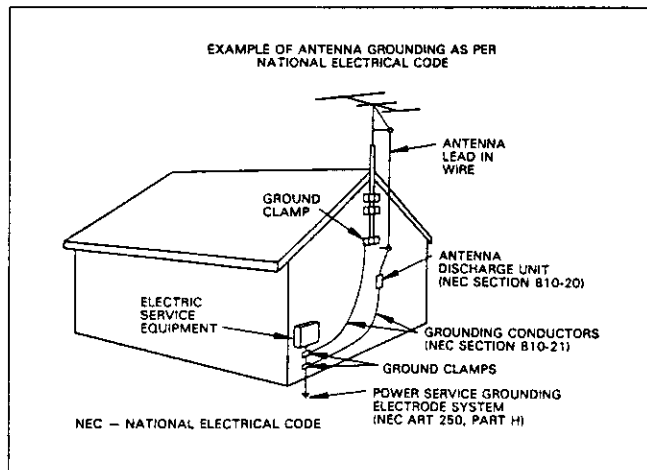

18. Power lines – An outdoor antenna should be located away from power lines.

19. AC outlets – Do not connect other audio equipment with a power consumption larger than that specified to the AC outlet on the rear panel. Never connect other electrical units, such as an iron or toaster, to it to prevent fire or electric shock.

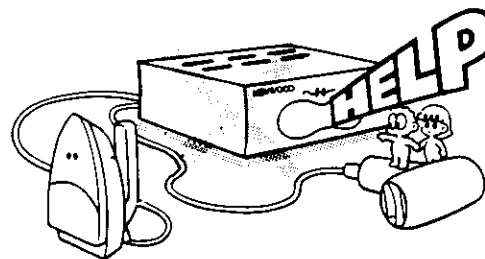

Notes:

- 1. Item 3 is not required except for grounded or polarized equipment.
- 2. Item 17 and 18 are not required except for units provided with antenna terminals.
- 3. Item 17 complies with UL in the U.S.A.

System connections

Make connections as shown in the diagram below. When connecting the related system components, refer also to the instruction manuals of the related components.

Do not plug in the power lead until all connections are completed.

■ Connection of audio components

For the connection of video components, please refer to page 22.

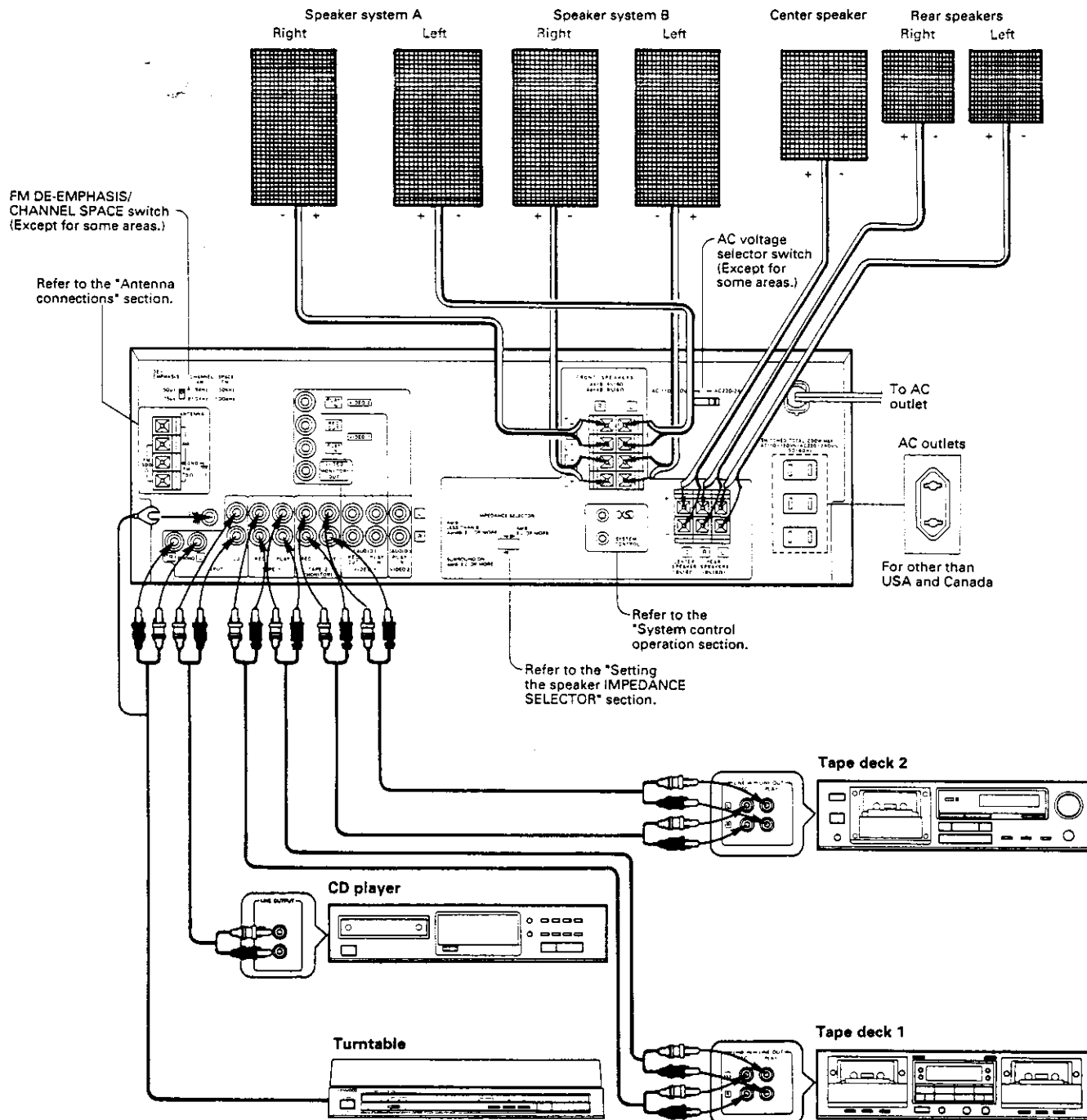

Notes:

1. Connect all cords firmly. If connections are loose there could be loss of sound or noise produced.
2. Do not connect up a power source which is larger than that indicated on the socket at the rear of the unit.
3. When plugging and unplugging connection cords, be sure to first remove the power cord from the AC outlet. Plugging/unplugging connection cords without removal of the power cord can cause malfunctions or damage to the unit.

Connection of antennas

- ① Push the lever.
- ② Insert the conductor.
- ③ Return the lever.

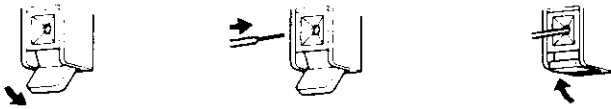

- Never short-circuit the + and - speaker cords.
- If the left and right speakers are connected inversely or if the speaker cords are connected with reversed polarity, the sound becomes unnatural with ambiguous acoustic image positioning. Be sure to connect the speakers and speaker cords correctly.

Setting the SPEAKER IMPEDANCE SELECTOR

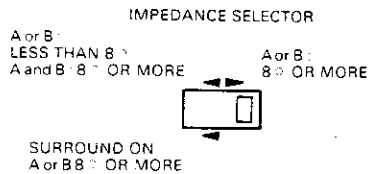

According to the impedance of the speakers used, set the SPEAKER IMPEDANCE SELECTOR on the rear panel as shown in the table.

- During speaker system connection and operation of the SPEAKER IMPEDANCE SELECTOR, set the POWER switch to OFF.

- When the IMPEANCE SELECTOR is in position, sound is not output from the center and rear speakers.

① When Surround speakers are not connected

Usable speaker impedance	Selector position
When speakers A and B are connected The impedance of both speakers should be $8\ \Omega - 16\ \Omega$	
When speakers A or B are connected When the impedance of the speakers is $8\ \Omega - 16\ \Omega$	
When the impedance of the speakers is $4\ \Omega - 6\ \Omega$	

② When Surround speakers are connected

Usable speaker impedance	Selector position
The impedance of the front speakers A and B, center speaker and rear speakers should be $8\ \Omega - 16\ \Omega$.	
When both of SPEAKERS A and B keys are ON, pressing the PRO LOGIC key or 3 STEREO key switches the speakers key setting to A ON alone. If the B key is pressed now, the SPEAKERS key setting will be switched to B ON alone.	

FM DE-EMPHASIS/CHANNEL SPACE switch (Except for some areas)

The FM DE-EMPHASIS/CHANNEL SPACE switch on the rear panel is set to the correct setting that prevails in the area to which the unit is shipped. However, if the FM DE-EMPHASIS/CHANNEL SPACE setting is not matched to the area where the unit is to be used; for instance, when you move from area 1 to area 2 or vice versa, desired reception of AM/FM broadcasts is not expected. In this case, change the FM DE-EMPHASIS/CHANNEL SPACE setting in accordance with the area corresponding to the table. The FM DE-EMPHASIS is switched over at the same time.

- When changing the setting of the FM DE-EMPHASIS/CHANNEL SPACE switch, first disconnect the power cord, then reset the channel space switch, connect the power cord again during pressing the TUNER key of the input selector, and turn the power on.
- When activating the CHANNEL SPACE switch, the preset memory contents of the tuner and the set up memory contents of the SURROUND function will be lost.

Area	CHANNEL SPACE freq.	FM DE-EMPHASIS
1 U.S.A., Canada, and South American countries.	FM : 100 KHZ AM : 10 KHZ	75 μ s
2 Other countries	FM : 50 KHZ AM : 9 KHZ	50 μ s

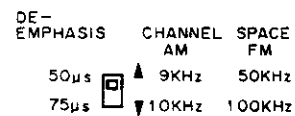

Connection of antennas

■ AM loop antenna connection

The supplied antenna is for indoor use. Place it as far as possible from the main system. TV set, speaker cords and power cord, and set it to a direction which provides the best reception.

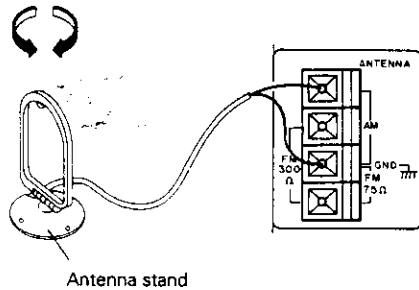

■ FM indoor antenna connection

The supplied antenna is for indoor use. For stable reception, remove the indoor antenna after installing an outdoor antenna as soon as possible.

- ① Find the position that provides best reception.
- ② Fix two ends with thumbtacks or drawing pins.

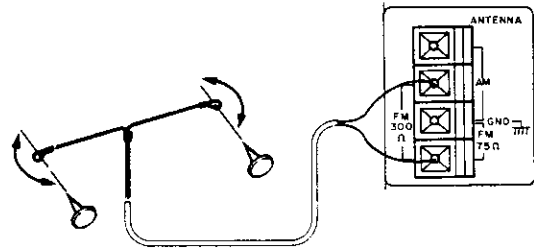

■ AM outdoor antenna connection

If the reception is poor when the AM loop antenna is used, distribute a vinyl-coated wire of more than 6 meters outdoors, without disconnecting the loop antenna.

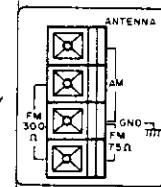
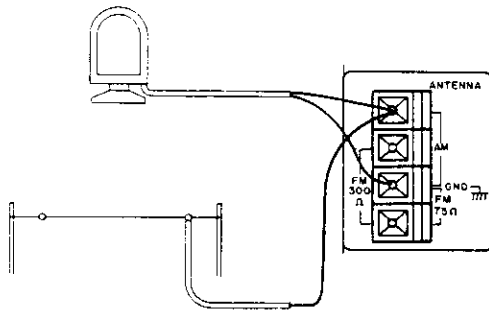

Connection method to each antenna terminal

- 1 Push lever down.
- 2 Insert conductor.
- 3 Return lever up.

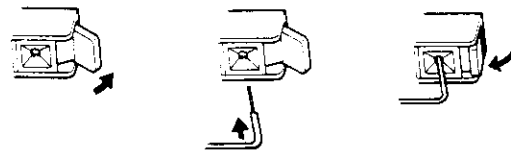

■ FM outdoor antenna connection

It is recommended to install an exclusive FM outdoor antenna to capture FM broadcasts with high should quality.

Use a coaxial cable for the connection between the outdoor antenna and FM ANTENNA terminal on the rear panel. For the connection between the coaxial cable and FM ANTENNA terminal, please refer to the illustration.

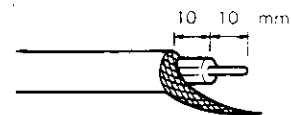
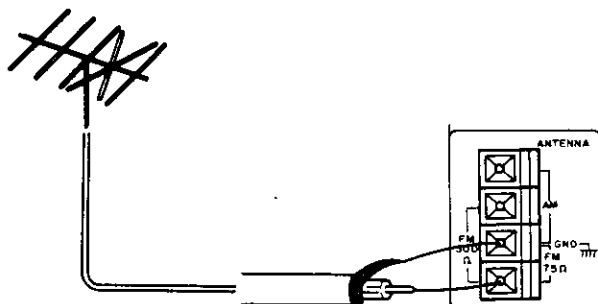

Connection of coaxial cable

Treat the coaxial cable tip as shown in the illustration, and fit the cable the terminals.

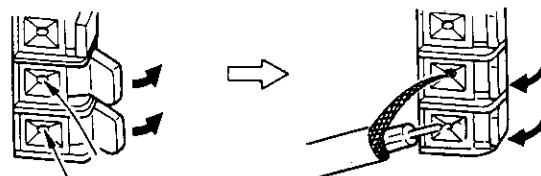

System control operation

Connection

Using the system control cords provided with KENWOOD system component models, make connections as shown below.

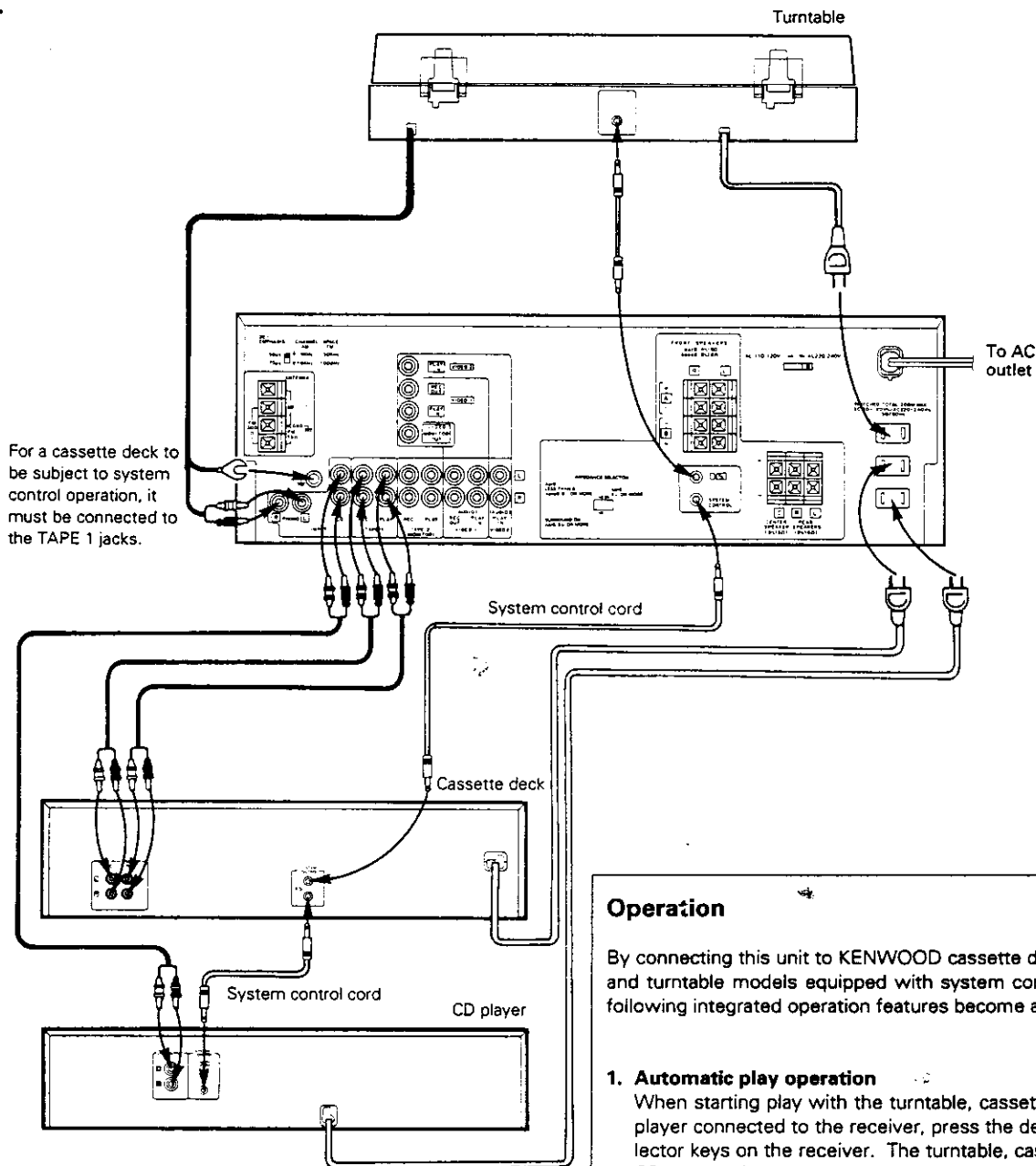

System control connection



- Be sure to insert the system control cord plugs fully into the SYSTEM CONTROL terminals.
- If the system control cord and audio cords are not connected properly, the automatic system governing remote control and system functions will not operate.

Operation

By connecting this unit to KENWOOD cassette deck CD player, and turntable models equipped with system control jacks, the following integrated operation features become available.

1. Automatic play operation

When starting play with the turntable, cassette deck, or CD player connected to the receiver, press the desired input selector keys on the receiver. The turntable, cassette deck, or CD player will automatically enter play mode.

In the same way, pressing the play key of turntable, cassette deck, or CD player will automatically switch the input selector on the receiver to the component on which the Play key is pressed.

2. Synchro recording

To record the sound from the CD player or turntable on to a tape with the cassette deck, press the CD or PHONO of the input selector keys and load a CD or record. Set the cassette deck to rec pause mode, then press the PLAY (START) key of the CD player or turntable. The cassette deck will start recording automatically, synchronized with the CD player or turntable starting play.

3. Remote control

The remote control unit provided with this unit, to which a KENWOOD system turntable, cassette deck, or CD player is connected, is equipped with related control keys. The related components can be controlled used these keys.

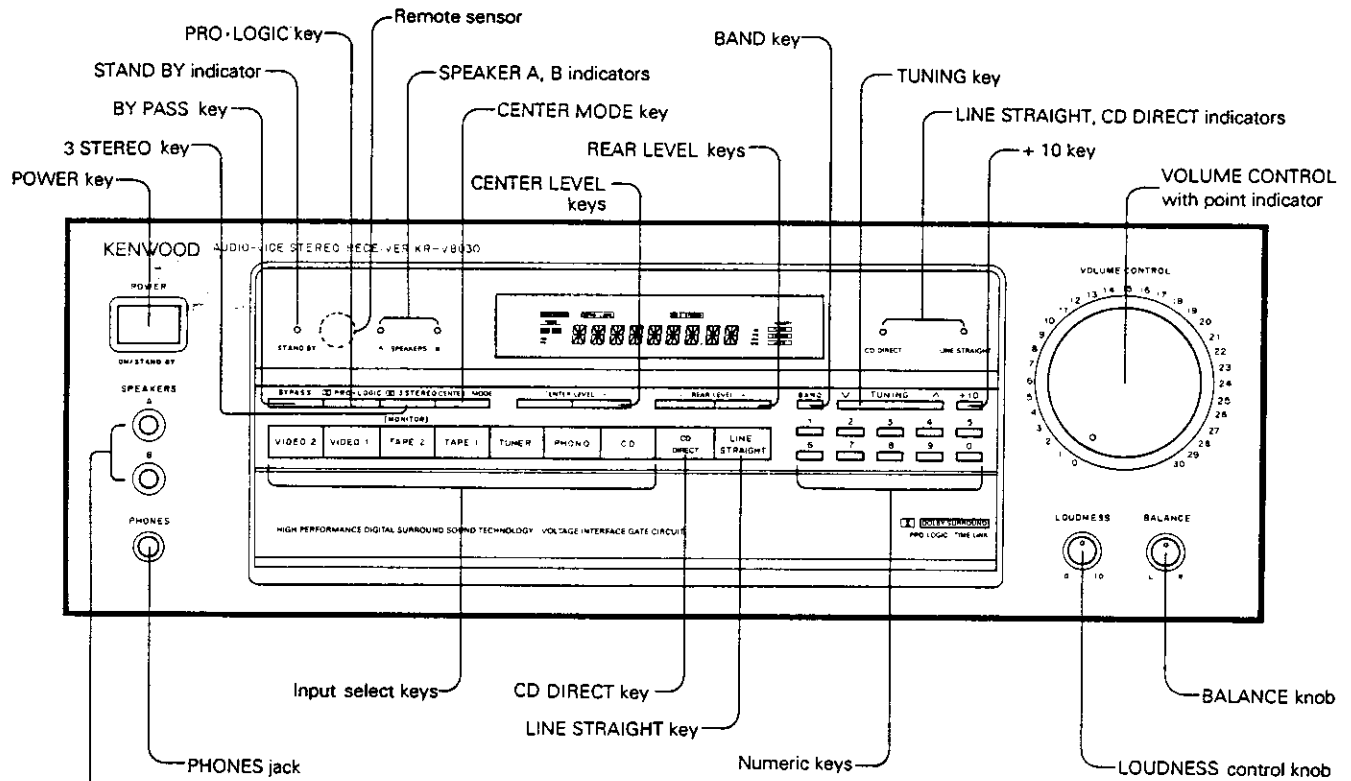

SPEAKER A and B keys

- A, B OFF** ● This position silences all speakers to permit private use of headphones.
- A ON** ● Activates speakers connected to the SPEAKERS A terminals on the rear panel.
- B ON** ● Activates the speakers connected to the SPEAKERS B terminals on the rear panel.
- A, B ON** ● Activates the speakers connected to the SPEAKERS A and B terminals simultaneously.

SPEAKERS



- When both of SPEAKERS A and B keys are ON, pressing the PRO LOGIC key or 3 STEREO key switches the SPEAKERS key setting to A ON alone. If the B key is pressed now, the SPEAKERS key setting will be switched to B ON alone.

STAND BY mode of POWER switch

When the power cord of this system is plugged into an AC outlet, the STAND BY indicator lights up regardless of the ON/OFF setting of the POWER switch. This indicates that a small amount of current is being supplied to the unit to back up the memory contents. This mode is referred to as the Stand By mode. While the STAND BY indicator is lit, the power of the system can be switched ON/OFF from the remote control unit.

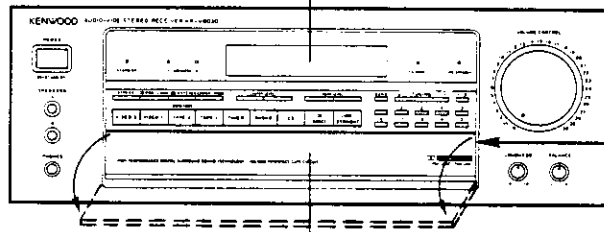
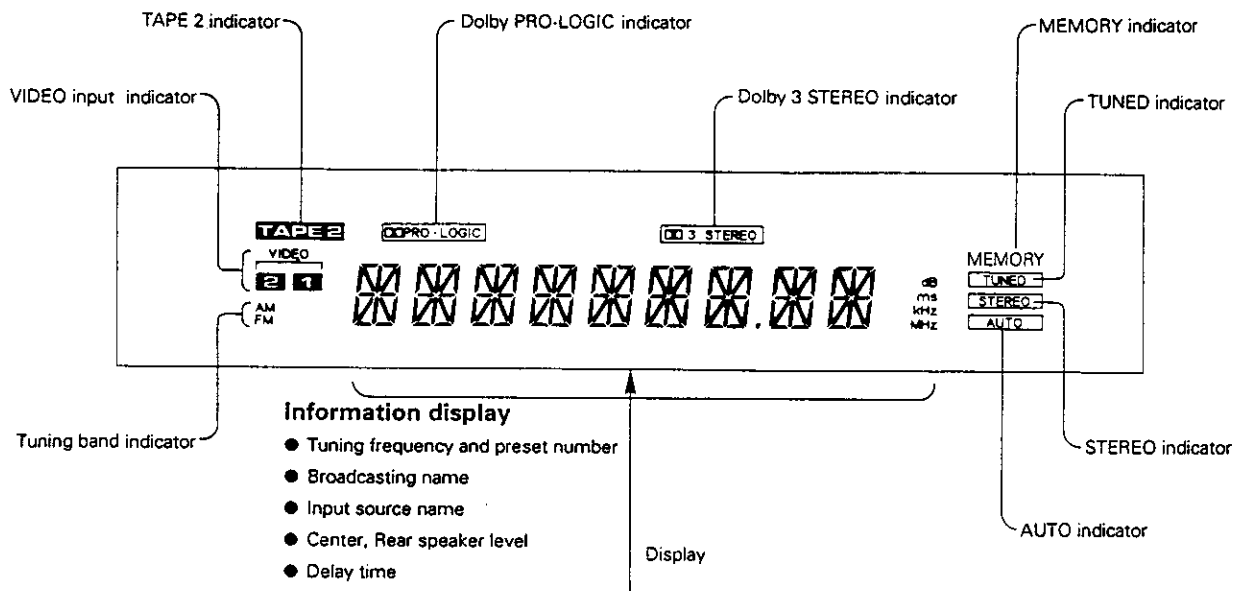

Push the bottom side of the door to open.

Push up the top side of the door to close.

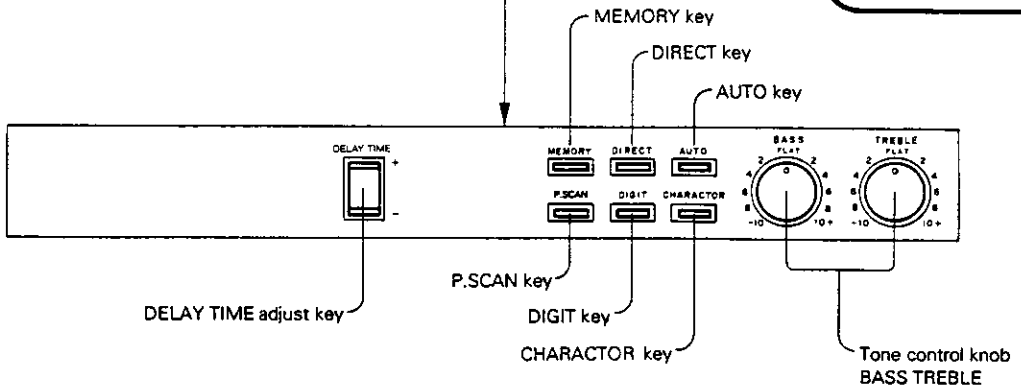

Operation of remote control unit

In addition to the remote control of the receiver unit, the provided remote control unit can control a KENWOOD cassette tape deck, CD player, turntable, graphic equalizer, etc., connected via the KENWOOD system control cords.

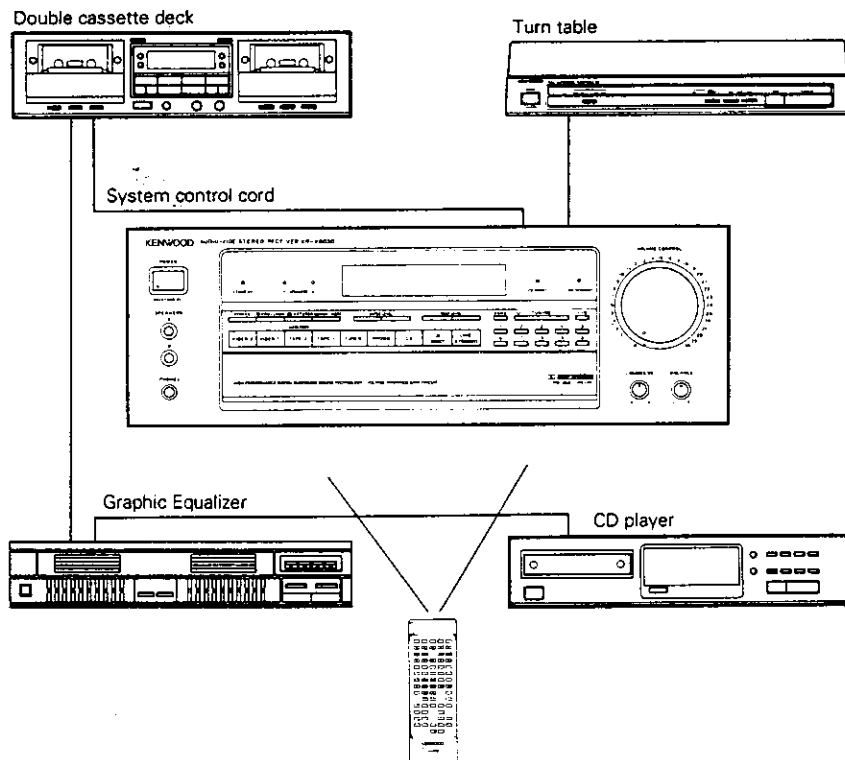

■ Loading batteries

1 Remove the cover.

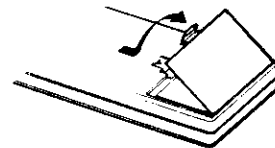

2 Remove the cover.

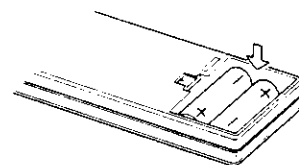

Insert two AA-size (R6/SUM-3) batteries as indicated by the polarity marking.

3 Close the cover.

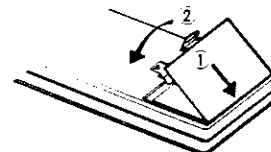

■ Operation procedure

Plug the power cord of the system into an AC wall outlet, and press the **POWER** key on the remote control unit to turn the power on.

When the power is turned on, press the key of the source component to be operated.

- When two operation keys on the remote control unit are pressed successively, press each key securely reserving an interval of more than 1 second for each press.
- Be sure to read the instruction manuals of the components connected via the system control cords.

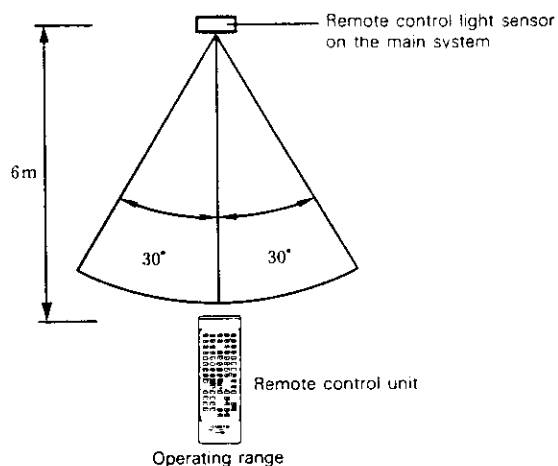

Notes:

1. The supplied batteries are intended for use in operation checks. Therefore, their lives may be shorter than ordinary batteries.
2. When the remote-controllable distance gets shorter than before, replace both batteries with new ones.
3. Malfunction may occur if direct sunlight or the light of a high-frequency lighting fluorescent lamp enters the remote control light sensor. In such a case, change the system installation position to prevent the malfunction.

POWER key

Press to switch the power ON/OFF.

TUNER operation keys

BAND: Switches the bands.
P. SCAN: Scans the preset stations.
DIRECT: In conjunction with the numeric keys, tunes stations directly.

Tape deck operation keys

Two sets of operation keys, the TAPE A and TAPE B keys, allow to operate a double-deck type cassette tape deck. Use the TAPE A keys if your cassette tape deck is of the single-deck type.

CD player operation keys

Operate the CD player.
DISC: The DISC key can be used as the disc selector key of a multi-disc player with a disc changer. For details, read the instruction manual provided with the CD player.

Numeric keys

When the CD source is selected, these keys can be used as the numeric keys of the CD player. When the TUNER source is selected, they can be used as the numeric keys of the tuner.

How to enter numerals:

For 23 press **+10** twice and 3

For 40 press **+10** four times and 0

Turntable operation keys

Control the start/stop of turntable.

Surround operation keys

The functions of the keys marked  in the following illustration can be operated from the remote control unit only. Read page 26 for details.

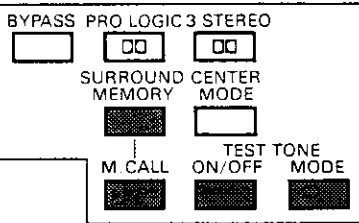

Graphic equalizer operation keys

M.CALL: Every time the key is pressed, the equalizer patterns are recalled from memory.

Input selector keys

Switches the input selector

Surround level control keys

CENTER LEVEL
REAR LEVEL
DELAY TIME

MUTE key

Press to reduce the volume temporary. During operation, the indicator on the VOLUME CONTROL knob blinks.

VOLUME CONTROL keys

Adjust the volume. During operation, the VOLUME CONTROL knob on the front panel turns and the indicator on the knob blinks at high speed.

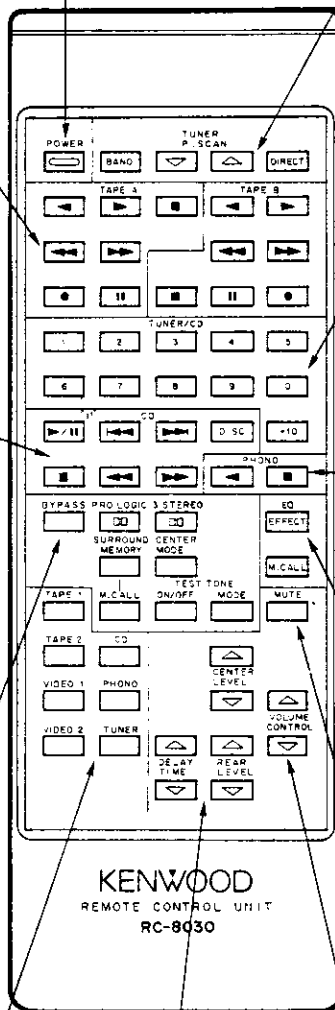

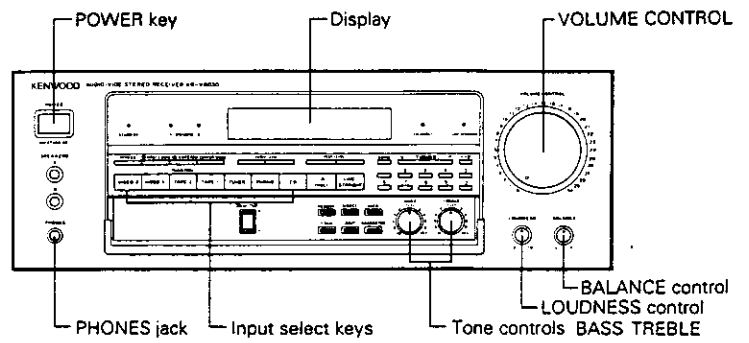

Basic operation

1 Press the POWER key to ON.

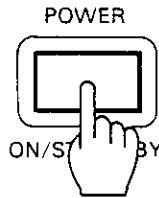

2 Select an input source.

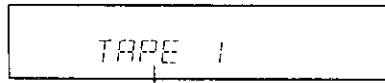

The source name characters appear on the display



- When the cassette deck, CD player and turntable are connected via the system control cord, any of these source components starts to be played automatically when the corresponding input selector switch is pressed.

3 Play the source component.

4 Adjust the volume.

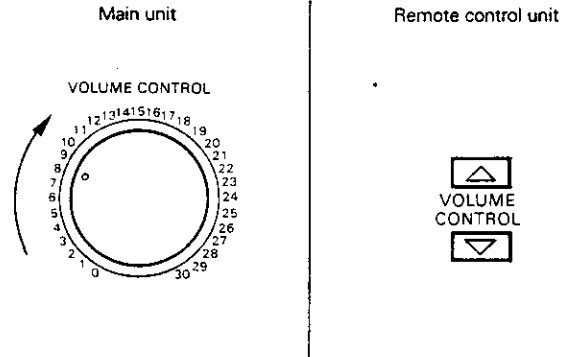

- When the volume is adjusted from the remote control unit, the VOLUME CONTROL knob on the main unit rotates while the point indicator is blinking.

5 Adjust the left and right volume balance.

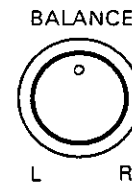

6 Adjust the tone.

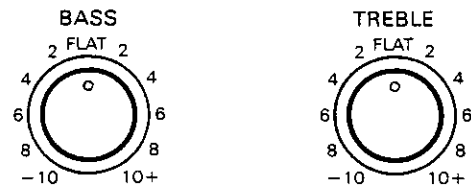

■ To mute the sound temporarily

REMOTE CONTROL ONLY

Press the MUTE key on the remote control unit.

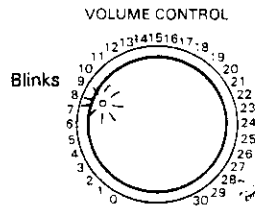

- The indicator on the VOLUME CONTROL knob on the front panel blinks.
- Pressing the key again resumes the previous volume.

■ Listening through headphones

1 Insert the headphone plug into the headphones jack.

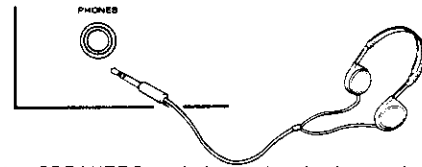

- Set the SPEAKERS switch so that both speaker systems A and B are OFF.

2 Adjust the volume.

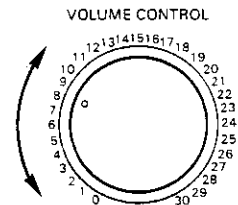

- Be sure to minimize the volume before unplugging the headphone plug.

Note on LOUDNESS control

Listening at high volume allows to enjoy dynamic sound, but human ears tend to feel low frequencies insufficient when listening at low volume. When the VOLUME CONTROL is set to a low position, the insufficiency of low frequencies felt by human ears can be compensated by turning the LOUDNESS control clockwise.

Enhances low frequencies.

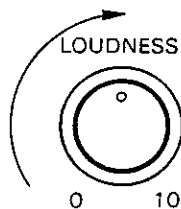

- The effect of LOUDNESS control is less sensible if the VOLUME CONTROL is set to the '5' position or above.

Notes:

1. When the TAPE 2 key is set to ON, the source selected with the INPUT SELECTOR cannot be heard from the speakers. To listen to a source other than cassette deck 2, be sure to set the TAPE 2 key to OFF.
2. The source selected with the INPUT SELECTOR is backed up for a few days even when the power cord is unplugged. After this period, the tuner is automatically selected when the power is supplied.

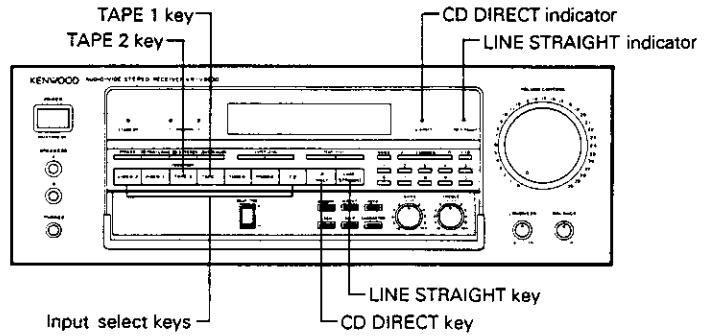

■ Operation of CD DIRECT playback

The digital sound of Compact Disc features an ideal reproduction characteristics, and the sound quality provided by CD can be reproduced with least degradation by means of the CD direct playback function.

■ Operation of LINE STRAIGHT playback

This CD, with least degradation of sound quality.

1 Press the CD DIRECT key.

2 Play the CD player.

● The CD DIRECT selection is given priority to any other source being selected by the INPUT SELECTOR.

1 Select an input source.

2 Press the LINE STRAIGHT key.

3 Play the input source.

To cancel the CD DIRECT playback function.

Press the CD DIRECT key again, or select the INPUT SELECTOR.

● CD DIRECT indicator goes off.

To cancel LINE STRAIGHT playback

Press the LINE STRAIGHT key again.

● LINE STRAIGHT indicator goes off.

Note:

During CD DIRECT or LINE STRAIGHT playback, the tone controls do not function.

■ Ordinary tape recording

- 1** Select the source to be recorded.

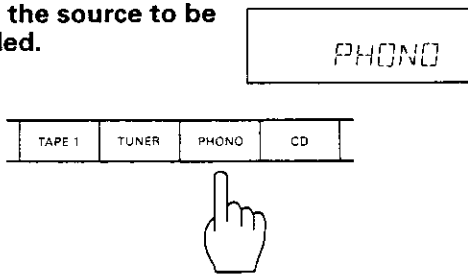

- 2** Set cassette deck 1 or 2 in the record-pause mode



Record-pause mode

- 3** Play the source component to be recorded, and start recording it on the cassette deck.

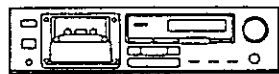

Recording starts.

- In case of tape dubbing (TAPE 1 → TAPE 2), play the cassette deck connected to TAPE 1 and record on the cassette deck connected to TAPE 2.

■ Tape dubbing (TAPE2 → TAPE1)

- 1** Press the TAPE 2 key.

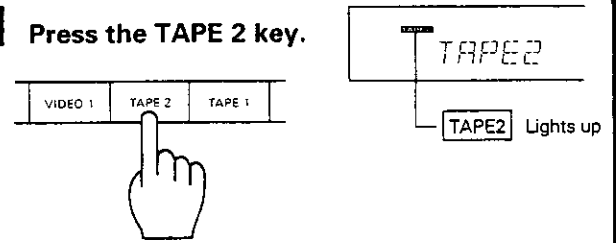

- 2** Select a source other than TAPE 1.

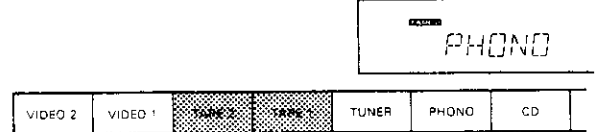

- 3** Play cassette deck 2 and start recording on cassette deck 1.



Play cassette deck 2.



Start recording on deck 1.

- Do not select TAPE 1 while dubbing.

Note:

For the tape-to-tape dubbing procedure using a double-deck type cassette tape deck, please read the instruction manual provided with the double-deck type cassette tape deck.

■ Listening to CD while recording another source

- 1** Select the source to be recorded.

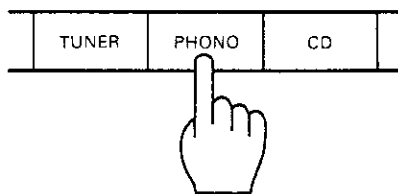

- 2** Play the source to be recorded.

- 3** Start recording on the cassette deck connected to the TAPE 1 jacks.



Recording starts.

- 4** Press the CD DIRECT key.

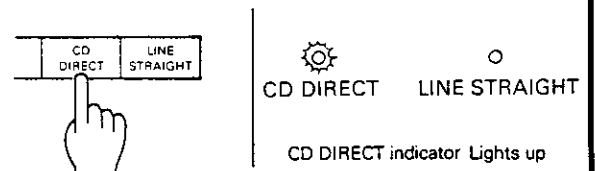

- 5** Play the CD player.

- No other source can be selected until the cassette deck recording is stopped.
- The source name on the display remains the same, i.e. the name of the recorded source.

Listening to broadcasts

■ Receiving broadcast stations and storing them in memory (preset operation)

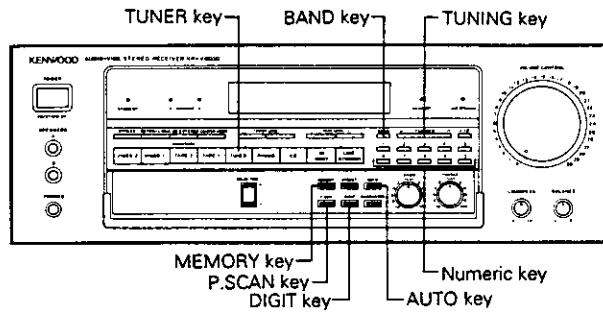

1 Press the TUNER key.

- Previous reception mode is resumed.
- Pressing the BAND key also set the unit to tuner mode.

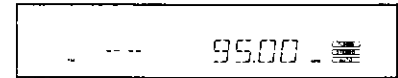
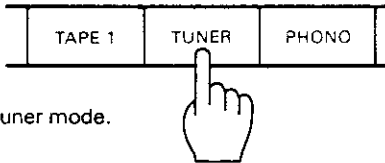

2 Select the broadcast band.

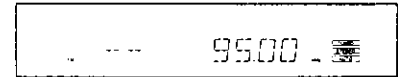

Each time the BAND key is pressed, the reception band changes between FM and AM.

3 Select the tuning mode.

- Normally, select the auto mode (with AUTO lighted).

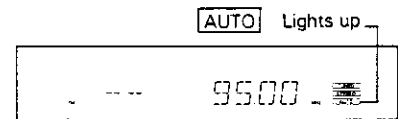

Press the key to select the auto (AUTO lighted) or manual (not lighted) mode.

4 Tune the desired station.

To decrease frequency

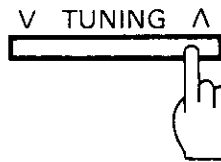

To increase frequency

- The TUNED indicator lights up when a station is received.
- Use manual tuning mode when the radio wave is weak and noisy. At this time, the stereo FM broadcast is received in monaural mode.

Auto tuning mode	Manual tuning mode
Press once. (Tuning stops automatically when a station is received.)	Press repeatedly, or press and hold, until the desired station is received.

5 Store the station in preset memory.

① Press the MEMORY key.

- Proceed the steps 2 while the MEMORY indicator is lighted.

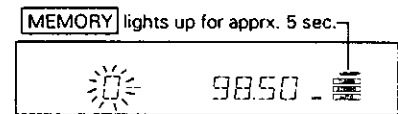

② Press the numeric key.

Ex.) To select preset No. 3:



To select preset No. 13:



To select preset No. 20:

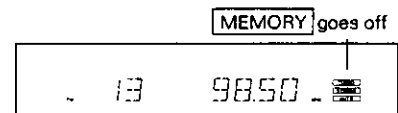
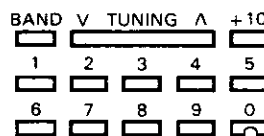
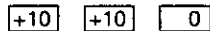

- Up to 20 stations can be preset at random, regardless of the reception band.
- When a station has previously been preset under the numeric key pressed, the newly preset station replaces the previous station.

When preset No. 13 is selected.

■ Receiving a preset station

Select the desired station.

Ex.) To select preset No. 3:
 To select preset No. 13: →
 To select preset No. 20: → →

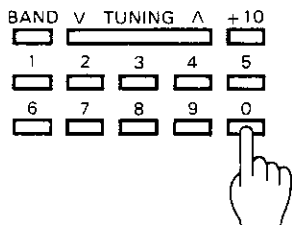

- The frequency of the station received will be displayed.

■ Listening to all preset stations in sequence (PRESET SCAN)

Press the P.SCAN key

Main unit



- preset stations are received in order to 1 → 2 → 3 ... 10 ... 20 every time the key is pressed.

Remote control unit

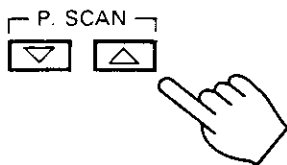

- preset stations are received in order to 1 → 2 → 3 ... 10 ... 20 every time the (UP) key is pressed, or in order of 20 → 19 → 18 ... 10 ... 1 every time (DOWN) key is pressed.

■ Direct tuning of radio stations

If you know the frequency of the desired station, it can be received directly by inputting the frequency using the numeric keys.

1 Select the broadcast band.

Each time the BAND key is pressed, the reception band changes between FM and AM.

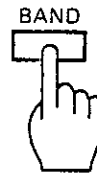

2 Press the DIRECT key.

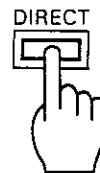

3 Input the frequency of the desired station by pressing the numeric keys.

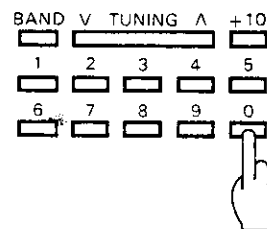

Example of input

Desired station	Order of pressing numeric keys
FM 90 MHz	<input type="text" value="9"/> <input type="text" value="0"/> <input type="text" value="0"/> (100 kHz space)
	<input type="text" value="9"/> <input type="text" value="0"/> <input type="text" value="0"/> <input type="text" value="0"/> (50 kHz space)
FM 102.5 MHz	<input type="text" value="1"/> <input type="text" value="0"/> <input type="text" value="2"/> <input type="text" value="5"/> (100 kHz space)
	<input type="text" value="1"/> <input type="text" value="0"/> <input type="text" value="2"/> <input type="text" value="5"/> <input type="text" value="0"/> (50 kHz space)
AM 810 kHz	<input type="text" value="8"/> <input type="text" value="1"/> <input type="text" value="0"/>
AM 1260 kHz	<input type="text" value="1"/> <input type="text" value="2"/> <input type="text" value="6"/> <input type="text" value="0"/>

Last channel memory

When the tuner's band selector is switched or when the input selector is switched from another source to TUNER, the last received station is recalled for each of FM, AM when the receiver power is switched ON.

■ Displaying station names

Station names composed of up to four digits of characters and/or symbols can be displayed on the tuner display. Example: To receive FM 98.80 MHz, input its name with characters "CBE", and preset them under numeric key **3**.

1 Receive FM 98.80 MHz, and enter the character input mode.

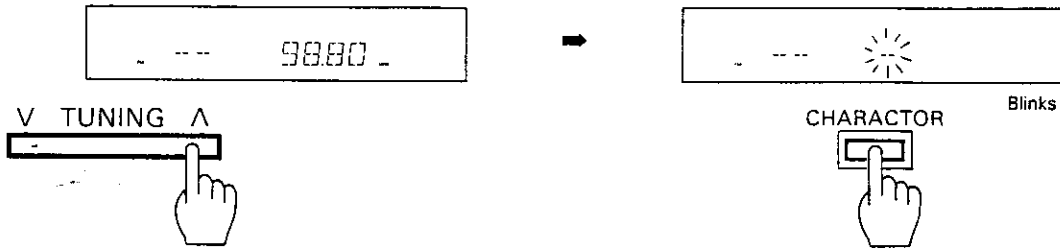

2 Select the characters to be displayed with that station.

① Display the desired character.

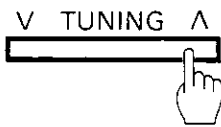

② Establish the selection.

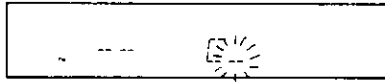
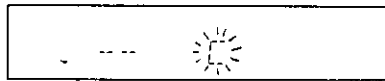

Blinking digit change to the next digit.

③ Repeat steps 1 and 2 until all of the required characters have been input.

- To select 'C', press the UP segment three times.
- To insert a space, simply press the DIGIT key.

Types of characters that can be input

After having pressed the CHARACTER key, press the TUNING key to display the characters available.

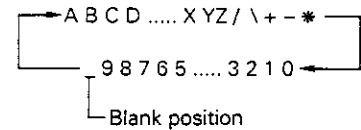

3 End the character input.

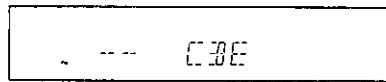
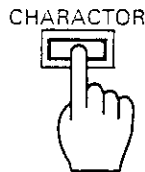

- The character input also terminates automatically when fourth character has been input.
- Press the CHARACTER key to terminate character input with three characters or less.

4 Preset them under key **3**.

① Press the MEMORY key.

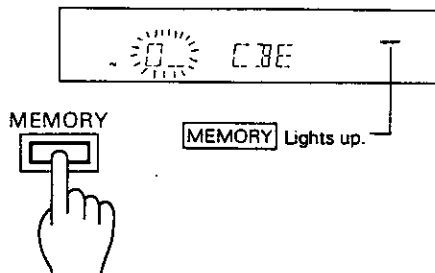

② Press numeric key **3**.

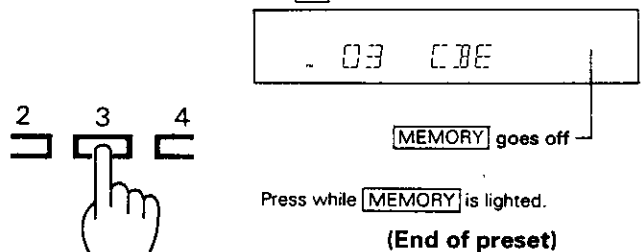

■ Changing a station name

Example: To change station name "FHN8" preset with AM (MW) 810 kHz frequency under key **2** to "FEN".

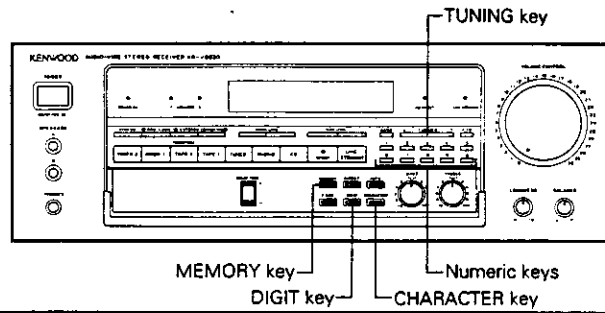

1 Receive preset station of **2** by preset tuning, and enter the character input stand-by mode.

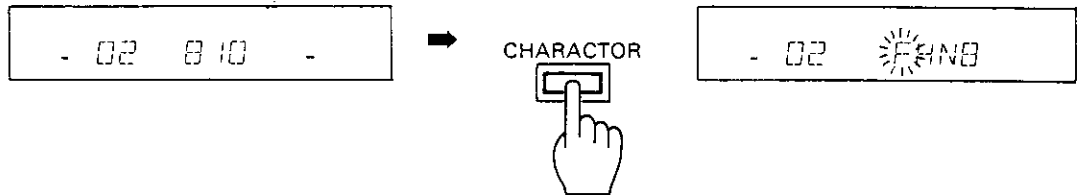

2 Move the blinking digit to the second digit.



3 Select "E" with the TUNING key.



4 Move the blinking digit by two digits.



5 Select the blank with the TUNING key.

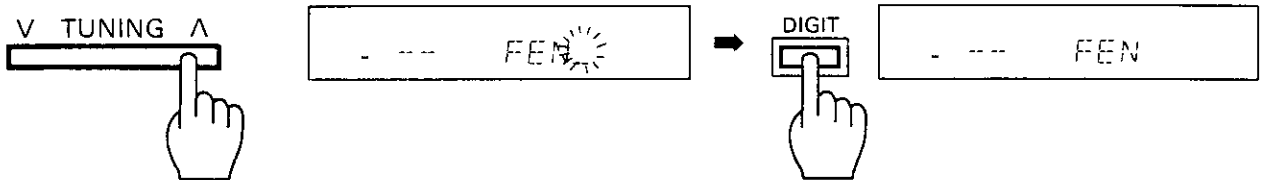

● The character input terminates automatically when fourth character has been input.

6 Preset the new name under numeric key **2**.

① Press the MEMORY key.

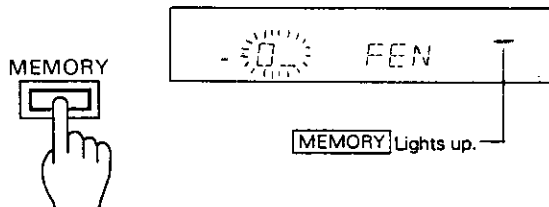

② Press numeric key **2**.

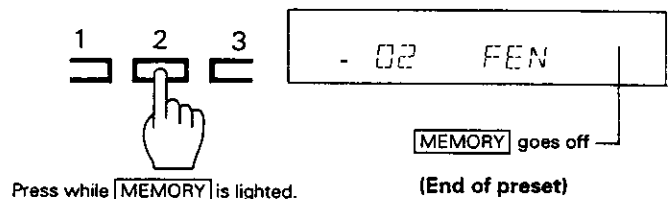

Operation with video components

For the connections and operations, also read carefully the instruction manuals supplied with the video components to be connected.

When connect to the KENWOOD LD player having system control terminal, do not connect anything to the system control terminal of the LD player.

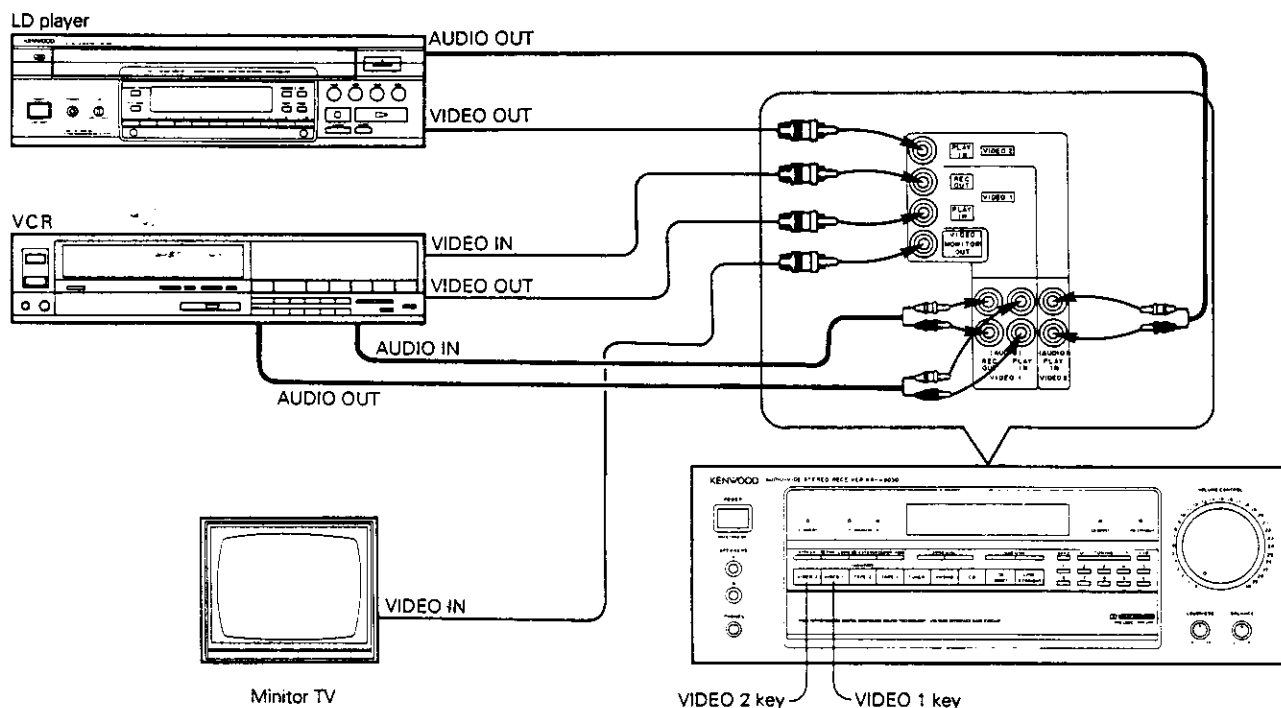

■ Playback of video tape

1 Switch the power of the monitor TV ON.

2 Press the VIDEO 1 key.

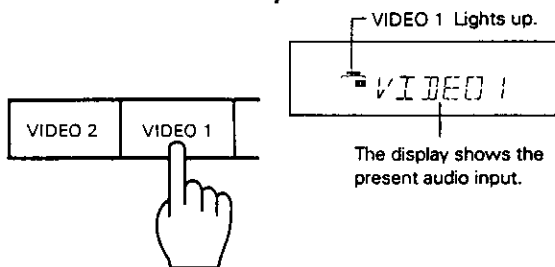

- When an input selector key other than VIDEO is pressed, the audio input of the selected source will be played in place of the audio input from VIDEO 1.

3 Play the VCR.

4 Adjust the volume.

■ Recording of video source

1 Connect the video source component to be recorded to the VIDEO 2 jacks.

- A video player deck, video camera, LD player, DBS tuner, etc., can be connected.

2 Press the VIDEO 2 key.

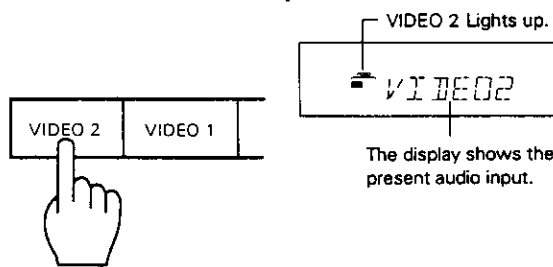

- When an input selector key other than VIDEO is pressed, the audio input of the selected source will be played in place of the audio input from VIDEO 2.

3 Play the video source component.

4 Put the VCR in the record mode.

DOLBY 3 STEREO

The Dolby 3 Stereo mode allows to enjoy "Dolby Surround" movies, etc., by combination of the front and center speaker sounds. The main effect of this mode is to provide a secure positioning of the center channel sound, such as words.

Precaution

If the SPEAKER IMPEDANCE SELECTOR at the rear is set to 'A or B: 8 Ω OR MORE', the DOLBY SURROUND mode or DOLBY 3 STEREO mode cannot be obtained.

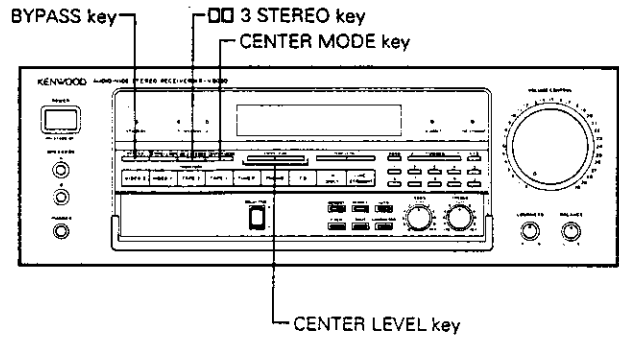

■ 3 STEREO balance adjustment

Remote control unit only

1 Press the 3 STEREO key.

2 Select the center mode.

- The center mode is switched between NORMAL - WIDE every time the CENTER MODE key is pressed.
- Refer to step 2 on page 25 for proper selection of center mode.

3 Generate the test tone.

- The speaker generating the test tone is changed every time the MODE key is pressed.

4 Adjust the center speaker volume.

Adjust the center speaker volume.
Adjust so that the level of the center speaker is equal to that of the left and right speakers.

5 Stop generating the test tone.

Press the TEST TONE ON/OFF key on the remote control unit.

■ 3 STEREO playback

1 Press the 3 STEREO key.

2 Select the center mode.

- The center mode is switched between NORMAL - WIDE every time the CENTER MODE key is pressed.

3 Play a stereo software program or a Dolby surround program.

4 Adjust the volume and tone.

To return to normal stereo playback from 3 STEREO

DOLBY SURROUND

Precaution

If the SPEAKER IMPEDANCE SELECTOR at the rear is set to "A or B: 8 Ω OR MORE", the DOLBY SURROUND mode or DOLBY 3 STREO mode cannot be obtained.

Dolby Surround field adjustment

Remote control unit only

First, set the sound balance for use in Dolby Surround playback by also using the remote control unit.

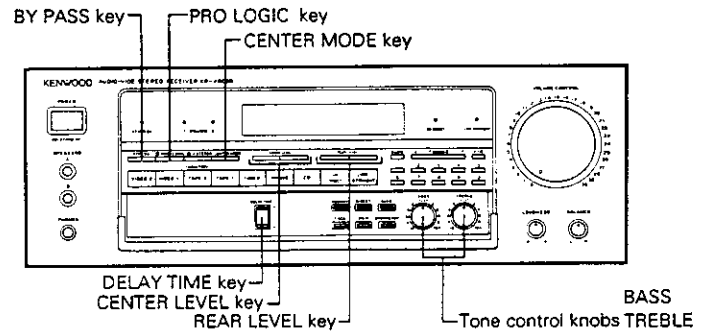

1 Switch Dolby Surround ON.



2 Select the center mode.

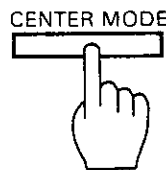

- Refer to step 2 on page 25 for proper section of center mode.

3 Generate the test tone.

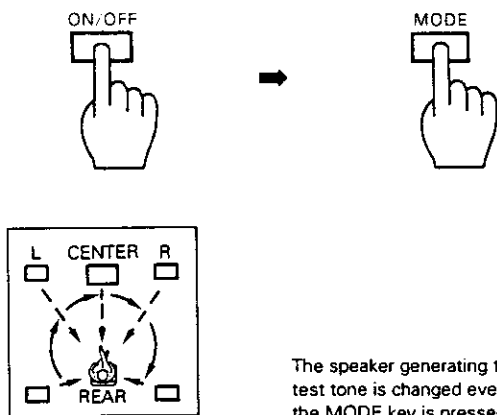

The speaker generating the noisy test tone is changed every time the MODE key is pressed.

In NORMAL or WIDE mode:
Test tone moves in the following order.

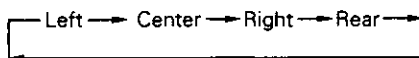

In PHANTOM or C-OFF mode:
Test tone moves in the following order.



4 Adjust the volume balance.

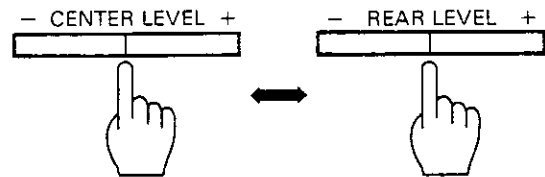

- Adjust so that the test tone volumes are the same on all speakers.
- The level being adjusted is displayed.

5 Turn the test tone OFF.

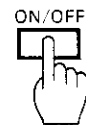

6 Set the delay time.

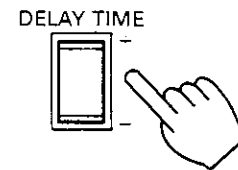

- Calculate the proper delay time for Dolby Surround by referring to the illustration below.
- The delay time can be adjusted in the range from 16 to 30 ms.
- When one of the DELAY TIME keys is pressed, the delay time is displayed and varied in 2.0 ms steps per press the key.
- Once a delay time is set, it is automatically held in memory so the same delay time is displayed whenever Dolby Surround is switched ON later.

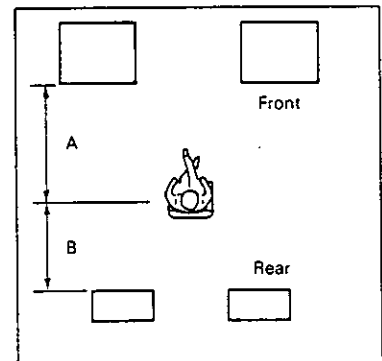

$$\text{Delay time (ms)} = 20\text{ms} + 3\text{ms} (A - B)$$

A : Distance of front speaker (m)

B : Distance of rear speaker (m)

■ Operation of Dolby Surround playback

When playing a video software program carrying "  SURROUND" mark, use the following procedure to obtain similar Dolby Surround effect to movie theaters.

1 Press the PRO-LOGIC key.

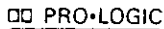
 PRO-LOGIC



Lights up.

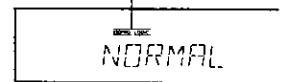

2 Select the center mode.

CENTER MODE

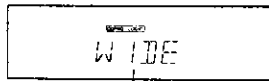

The display returns to the input source display in about 5 seconds.

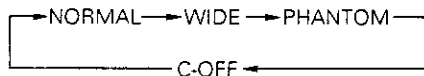

Every time the key is pressed, the center mode is switched as shown above, and the name of the mode is displayed.

NORMAL

- Use this mode with a center speaker of a compact size.
- This improves the sound positioning of medium and higher frequencies.
- Use this mode when the optional CS-7 center speaker is used.

WIDE

- Use this mode with a center speaker of a medium or larger size.
- This improves the sound positioning all over the frequency range.
- If you cannot identify whether your center speaker is of the medium or compact size, try both the NORMAL and WIDE mode and use the one that can provide better sound positioning.

PHANTOM

- Use this mode when the center speaker is not used.
- Even without the center speaker, the signal is processed in a simulated manner to ensure proper center image positioning and provide the enjoyment of Dolby Surround.

C-OFF

- Turns the center speaker sound off.

3 Play a software program encoded with Dolby Surround.

4 Adjust the volume.

- Once the "Dolby Surround sound field adjustment" has been made, do not change the positions of the REAR LEVEL, CENTER LEVEL and DELAY TIME keys.

VOLUME CONTROL

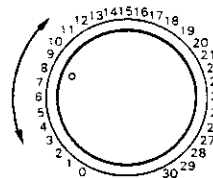

Adjusts the overall volume.

5 Adjust the tone.

Adjusts the low frequencies.

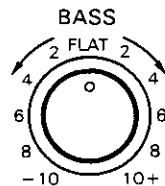

TREBLE

Adjust the high frequencies.

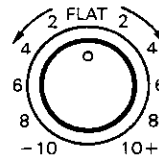

To return to normal stereo playback from Dolby Surround:

BYPASS

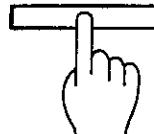

goes off.

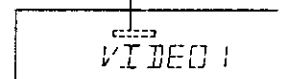

Dolby surround

■ Storing Surround setup in memory

Remote control unit only

Setups for DOLBY 3 STEREO and PRO LOGIC playback can be stored in memory and recalled by simple operation. Up to four setups can be stored in memory.

1 Set a sound field for Dolby 3 Stereo or Pro Logic playback.

Set the playback condition referring to pages 23, 24 and 25.

The setup contents which can be stored in memory are as follows.

DOLBY 3STEREO – CENTER MODE – CENTER LEVEL

DOLBY PRO-LOGIC – CENTER MODE – DELAY TIME – CENTER LEVEL – REAR LEVEL

2 Press the SURROUND MEMORY key on the remote control unit.

SURROUND MEMORY

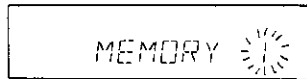

- The MEMORY indicator is displayed for 5 seconds; perform steps 3 and 4 in this period.

3 Select a memory number.

M.CALL

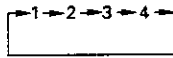
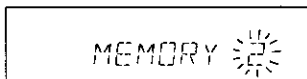
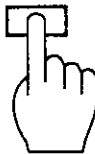

The displayed memory No. changes every time the M.CALL key on the remote control unit is pressed.

4 Store the setup in memory.

SURROUND MEMORY



Press again.

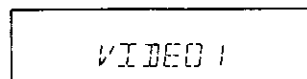

The input source display resumes.

■ Recalling Surround setup from memory

Remote control unit only

Select the memory number.

M.CALL

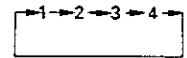
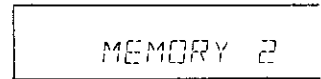

The displayed memory No. changes every time the M.CALL key on the remote control unit is pressed.

- The stored contents with the memory No. being displayed are represented.

Remote control unit

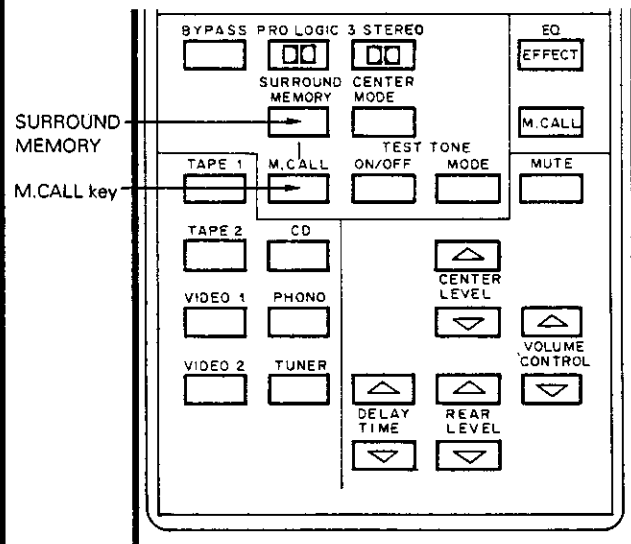

Surround speakers

Surround rear speakers and center speaker are necessary for full enjoyment of the Dolby Surround effects.

Surround rear speaker: Enhances the feeling of presence in the listening room.

Center speaker: Clarifies the positioning of words in movies or acoustic image of musical instruments located on the center.

- Connect the optional KENWOOD Surround rear speakers and center speaker referring to page 6.

Arrangement of Surround speakers

- Rear speakers can be placed with various arrangements according to the listening room size and its reverberation characteristics. The example shown in the illustration is a typical example among several arrangements which allow efficient enjoyment of Surround effects. In addition to it, other arrangements are also possible. Please install the rear speakers according to your individual taste as well as to the listening room.

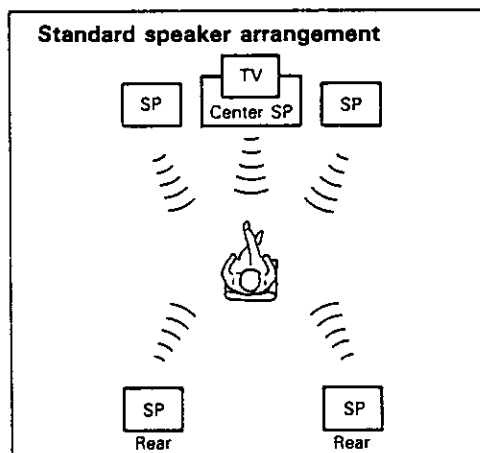

- The ideal location of the center speaker is on the same axis as the front of the TV screen. Please install the center speaker above, below or on the side of the TV set, for example, so that the best positioning or acoustic image can be obtained.

Delay time

As shown in the example of illustration, the sound of piano played on the stage attains the ears of listener as a synthesis of the direct sound from piano, the indirect sounds which are reflected once or twice by the reflectors, ceiling and side and back walls, and the reverberation sounds which repeat infinite reflections until they fade out completely.

The indirect sounds always pass through longer routes compared to the direct sound. The delay between the direct and indirect sounds is called the DELAY TIME, and the level of the indirect or reverberated sounds is called the PRESENCE LEVEL. The indirect sounds accompanied with delay play a very important role in providing better sound effects and the feeling of presence of concert halls, etc. The acoustic field also varies depending on the speaker arrangement. It is recommended to try various delay time setting to obtain the best sound field possible.

Example of a concert hall

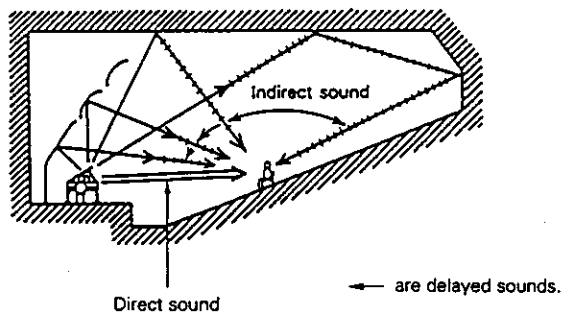

In case of difficulty

What appears to be a malfunction may not always be serious. If your unit should not perform as expected, consult the table below to see if the problem can be corrected before seeking help from your dealer or service representative.

Remote control unit

Symptom	Cause	Remedy
Remote control operation is not possible.	<ul style="list-style-type: none"> ● Batteries are exhausted. ● The audio cords and the system control cords are not connected properly. ● The remote control unit is too far away from the main system, controlling angle is too large, or there is an obstacle in between. ● The source component to be operated does not contain the analog disk, tape(s) or CD. ● An attempt is made to play a tape which is being recorded in the cassette deck. 	<ul style="list-style-type: none"> ● Replace with new batteries. ● Connect properly referring to "System connections". ● Operate the remote control unit within the controllable range. ● Place an analog disk, tapet(s) or CD in the source component to be played. ● Wait until the recording is completed.

Amplifier section

Symptom	Cause	Remedy
Sound is not output.	<ul style="list-style-type: none"> ● The speaker cords are disconnected. ● The VOLUME is set to the minimum position. ● The MUTING key of the remote control unit. is set to ON and the point indicator is blinking. 	<ul style="list-style-type: none"> ● Connect them properly referring to "System connections". ● Adjust the volume to a proper level. ● Press the MUTING key to OFF.
No sound comes out, and "PROTECT" is shown on the display.	<ul style="list-style-type: none"> ● Speaker cords are short-circuited. 	<ul style="list-style-type: none"> ● Turn the power off, eliminate the short-circuiting, then turn on the power again.
Sound is not output from one of the speakers.	<ul style="list-style-type: none"> ● The speaker cord is disconnected. ● The BALANCE control is set to an extreme position. 	<ul style="list-style-type: none"> ● Connect it properly referring to "System connections". ● Adjust the Left/Right balance.
Sound is not output from the Surround rear speaker and/or center speaker, or their sound is very small.	<ul style="list-style-type: none"> ● The rear-speaker cords and/or center speaker cord are disconnected. ● The Surround play mode has not been engaged. ● The REAR LEVEL and/or CENTER LEVEL controls are set to the minimum level. ● The SPEAKER IMPEDANCE SELECTOR on the rear panel is set to the SURROUND off side. 	<ul style="list-style-type: none"> ● Connect them properly referring to "System connections". ● Set the Dolby Surround or 3 STEREO mode. ● Adjust the REAR LEVEL and CENTER LEVEL controls. ● Set the SPEAKER IMPEDANCE SELECTOR to the SURROUND ON side.
A hum noise is generated when the PHONO input selector key is pressed.	<ul style="list-style-type: none"> ● The audio cord from the turntable is not inserted securely into the PHONO jacks. ● The turntable is not grounded. 	<ul style="list-style-type: none"> ● Insert the audio cord plugs securely into the PHONO jacks. ● Connect the grounding wire to the GND terminal on the rear panel.

Tuner section

Symptom	Cause	Remedy
Radio stations cannot be received.	<ul style="list-style-type: none"> ● No antenna is connected. ● The broadcast band is not set properly. ● The frequency of the desired station is not tuned. 	<ul style="list-style-type: none"> ● Connect an antenna. ● Set the broadcast band properly. ● Tune the frequency of the desired station.
A station which was preset cannot be received by pressing the corresponding numeric key.	<ul style="list-style-type: none"> ● The preset station belongs to a frequency that cannot be received. ● The preset memory was cleared because the power cord had been unplugged for a long period of time. 	<ul style="list-style-type: none"> ● Preset a station with a receivable frequency. ● Preset the station again.
Interference.	<ul style="list-style-type: none"> ● Noise due to ignition noise of an automobile. ● Noise due to an influence from an electric appliance. ● Noise due to a nearby TV set. 	<ul style="list-style-type: none"> ● Install the outdoor antenna apart from the road. ● Turn off the power of the appliance. ● Install the system more apart from the TV set.

Notes:

1. This system is microprocessor-controlled, so malfunction may occur due to external noise or interference noise. In such a case, unplug the power cord, plug it and turn power on again.
If the trouble still persists, unplug the power cord and connect the power cord again while pressing the TUNER key of the input selectors.
2. Do not use contact cleaners because it could cause a malfunction. Be specially careful against contact cleaners containing oil, for they may deform the plastic components.

Manufactured under license from Dolby Laboratories Licensing Corporation. Additionally licensed under one or more of the following patents: U.S. numbers 3,632,886, 3,746,792 and 3,959,590; Canadian numbers 1,004,603 and 1,037,877.
"Dolby" and the double-D symbol are trademarks of Dolby Laboratories Licensing Corporation.

For the U.S.A. FCC WARNING:

This equipment may generate or use radio frequency energy. Changes or modifications to this equipment may cause harmful interference unless the modifications are expressly approved in the instruction manual. The user could lose the authority to operate this equipment if an unauthorized change or modification is made.



(For the U.S.A. & Canada)

Audio section

Rated power output at the STEREO operation

120 watts per channel minimum RMS, both channels driven at 8 Ω , from 20Hz to 20,000Hz with no more than 0.06% total harmonic distortion. (FTC)

Power output at the Surround operation

Front (1kHz, 0.9% T.H.D. at 8 Ω) 75W + 75W
Center (1kHz, 0.9% T.H.D. at 8 Ω) 75W
Rear (1kHz, 0.9% T.H.D. at 8 Ω) 15W + 15W

Total harmonic distortion (1kHz, 8 Ω) 0.03% at 60W

Frequency response

CD 10Hz – 50kHz +0dB
-3dB

Signal to noise ratio (IHF-A)

PHONO (MM) 78dB for 5mV input
CD, TAPE, VIDEO 100dB for 200mV input

Input sensitivity/impedance

PHONO (MM) 2.5 mV/47k Ω
CD, TAPE, VIDEO 200mV/47k Ω

Tone controls

BASS ± 10 dB (at 100Hz)
TREBLE ± 10 dB (at 10kHz)

Video section

VIDEO Inputs/outputs 1 Vp - p, 75 Ω unbalanced

FM Tuner section

Tuning frequency range 87.5MHz–108MHz
Antenna impedance 75 Ω unbalanced

Sensitivity (IHF) 10.8dBf (0.95 μ V at 75 Ω)

50 dB quieting sensitivity

MONO 16.2 dBf (3.5 μ V at 75 Ω)
STEREO 38.2 dBf (45 μ V at 75 Ω)

Total harmonic distortion at 1,000Hz

MONO 0.3%
STEREO 0.5%

Signal to noise ratio at 65 dBf (IHF)

MONO 79dB
STEREO 73 dB

Selectivity (IHF ± 400 kHz) 53 dB

Stereo separation (IHF at 1 kHz) 45dB

Frequency response 30Hz – 15 kHz +0.5 dB
-2.0 dB

AM Tuner section

Tuning frequency range 530kHz – 1,700kHz

Usable sensitivity 12 μ V/(400 μ V/m)

Total harmonic distortion 0.5%

Signal to noise ratio 50dB

Selectivity 23dB

General

Power consumption 3A

Dimensions 440 (W) x 158 (H) x 415 (D) mm
(17-5/16") x (6-1/4") x (16-5/16")

Weight (net) 12.0 kg (26.5 lb)

AC outlets switched x 3, total 200W, 1.6A max.

Note:

KENWOOD follows a policy of continuous advancement. For this reason specifications may be changed without notice.



(For other countries)

Audio section

Rated power output at the STEREO operation

(IHF '66) from 20Hz to 20 kHz, 0.06 % T.H.D.,
at 8 Ω 130W + 130W

Power output at the Surround operation

Front (1kHz, 0.9% T.H.D. at 8 Ω) 75W + 75W
Center (1kHz, 0.9% T.H.D. at 8 Ω) 75W
Rear (1kHz, 0.9% T.H.D. at 8 Ω) 15W + 15W

Total harmonic distortion (1kHz, 8 Ω) 0.03% at 60W

Frequency response

CD 10Hz - 50kHz +0dB
-3dB

Signal to noise ratio (IHF-A)

PHONO (MM) 78dB for 5mV input
CD, TAPE, VIDEO 100 dB for 200mV input

Input sensitivity/impedance

PHONO (MM) 2.5 mV/47k Ω
CD, TAPE, VIDEO 200mV/47k Ω

Tone controls

BASS ±10dB (at 100Hz)
TREBLE ±10dB (at 10kHz)

Video section

VIDEO Inputs/outputs 1 Vp - p, 75 Ω unbalanced

FM Tuner section

Tuning frequency range 87.5MHz-108MHz
Antenna impedance 300 Ω balanced & 75 Ω unbalanced

Sensitivity (IHF) 10.8 dBf (0.95 μV at 75 Ω)
50 dB quieting sensitivity

MONO 16.2 dBf (3.5 μV at 75 Ω)
STEREO 38.2 dBf (45 μV at 75 Ω)

Total harmonic distortion at 1kHz

MONO 0.3%
STEREO 0.5%

Signal to noise ratio at 65dBf (IHF)

MONO 79dB
STEREO 73dB

Selectivity (IHF ± 400kHz) 53dB

Stereo separation (IHF at 1 kHz) 45dB

Frequency response 30Hz - 15 kHz +0.5dB
-2.0dB

AM Tuner section

Tuning frequency range

9 kHz step 531 kHz~1,602 kHz
10 kHz step 530 kHz~1,610 kHz

Usable sensitivity 12 μV/(400 μV/m)

Total harmonic distortion 0.5%

Signal to noise ratio 50dB

Selectivity 23dB

General

Power consumption 300W (IEC)

Dimensions 440 (W) x 158 (H) x 415 (D) mm
(17-5/16") x (6-1/4") x (16-5/16")

Weight (net) 12.0 kg (26.5 lb)

AC outlets switched x 1, 200W max.

Note:

KENWOOD follows a policy of continuous advancement. For this reason specifications may be exchanged without notice.